



WIRELESS OTOSCOPE

DE550/551 User Manual



THANKS FOR SELECTING A WIRELESS FIREFLY OTOSCOPE

To take full advantage of this product's advanced capabilities, and to properly and safely use this product, please read the manual carefully.

Copyright 2016 by Firefly Global. All rights are reserved. No one is permitted to reproduce or duplicate, in any form, this manual or any part thereof without permission from Firefly Global (www.Fireflyglobal.com).

Firefly Global assumes no responsibility for any injury, or for any illegal or improper use of the product, that may result from failure to use this product in accordance with the instructions, cautions, warnings, or indications for use published in this manual.

Software in this product is copyright of Firefly Global and its vendors. All rights are reserved. The software is protected by U.S. and international copyright laws and international treaty provisions applicable worldwide. Under such laws, the licensee is entitled to use the copy of the software incorporated with this instrument as intended in the operation of the product in which it is embedded. The software may not be copied, decompiled, reverse-engineered, disassembled or otherwise reduced to human-perceivable form. This is not a sale of the software or any copy of the software; all rights, title, and ownership of the software remain with Firefly and/or its vendors.

Caution: Changes or modifications not expressly approved by Firefly Global will void the purchaser's authority to operate the equipment and its warranty.



MDSS GmbH
Schiffgraben 41
30175 Hannover, Germany



Tested To Comply
With FCC Standards
For Home or Office Use

Table of Contents

Introduction	4
Warnings & Cautions	5
Check List	7
Nomenclature	8
Operation	9
Setting up the Otoscope with Specula:	9
Connecting to PC and Powering the Device On:.....	10
Charging the Battery:	11
Channel Mapping:	11
Recommended Holding Position:	12
Brightness Adjustment:	12
Using the Image Capture Control:	12
Using Focus:.....	13
Launching the Software Application for Windows:	15
Viewing the Images:	15
Saving Images and Changing Image File Type:.....	16
Changing the Location where Images are Saved:.....	17
Changing the Location of an Image Already Taken:	17
Launching the Software Application for Mac:	20
Viewing the Images:	20
Album Manager Feature:	21
Selecting Correct Device:.....	21
Saving Images or Videos:	22
Deleting or Renaming an Image or Video Already Taken:	22
Creating a New Folder or Setting Default Folder:	23
Moving an Image:	24
Icons and Functions:	24
Maintenance and service	25
Service policy	26
Specifications	27
Limited Warranty	28
Troubleshooting	31

INTRODUCTION

The Wireless Firefly Otoscope System consists of a wireless digital Otoscope, a compact USB receiver, software application and a charge cable. Only a computer equipped with a free USB port is needed to use the system.

The Wireless Firefly Otoscope System is designed for effective operation under a variety of conditions and typical video parameters are set at the factory. The software allows users to adjust most parameters including Saturation, Hue, Brightness, Contrast and Sharpness for desired applications.

System Requirements

The Firefly Otoscope System requires a user PC system running Windows XP Service Pack 2 or later operating system, a viewing screen, and a PC with an available USB 1.1 or 2.0 port.

Intended use

The Wireless Firefly Otoscope System is intended to allow inspection of the external ear, ear canal, and tympanic membrane under magnification.

User Profile

The Wireless Firefly Otoscope System is intended for applications such as:

- Science Education
- Medical examinations
- Veterinary use
- Self-health monitoring

Warranty Registration

Register your Firefly device at <http://www.fireflyglobal.com/warranty-registration/> within two weeks of your purchase and maintain your original receipt.

WARNINGS & CAUTIONS

Please familiarize all operating personnel with the general safety information in this summary. Specific warnings and cautions are also found throughout this manual.

Warning



A warning statement in this manual identifies a condition or practice which if not corrected or discontinued immediately, could lead to injury, illness, or death.

- Do not use in the presence of flammable anesthetics.
- This product has no user serviceable/replaceable parts. Please refer all service to authorized service personnel.
- This instrument is not intended to be used in the eye.

Caution



A caution statement in this manual identifies condition or practice, which if not corrected or discontinued immediately, could lead to equipment failure, equipment damage, or data loss.

- In order to obtain optimum performance and ensure patient safety, thoroughly read this manual.
- Do not use the Firefly Otoscope if you notice any signs of damage to the components of the system. Contact customer service for immediate assistance.
- Do not attempt to disinfect the Firefly Otoscope System using glutaraldehyde products, ethylene oxide gas, steam or any other liquid or gas disinfectant.
- The signal output (USB Port) connector is intended for connection of only devices complying with IEC 60601-1, or other IEC standards (for example, IEC 60950), as appropriate to the device. Connecting additional devices to the Firefly Otoscope System is not allowed.
- This product complies with current required standards for electromagnetic interference and should not present problems to other

equipment or be affected by other devices. As a precaution, avoid using this device in close proximity to other equipment.

- Do not apply alcohol, chemicals, or water to the lens. Any liquids entering the optical assembly will damage internal components.

CHECK LIST

Before starting, check that all the following items have been included with your product. If anything is missing, contact your dealer.

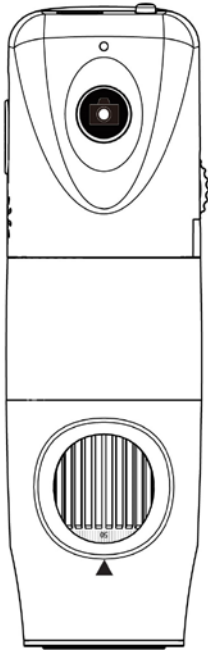

Otoscope x 1pc

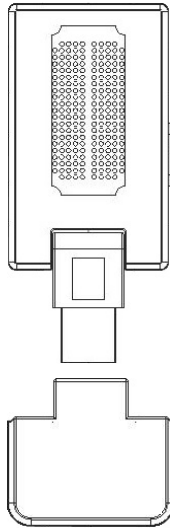

Receiver x 1 pc



USB charger cable x 1 pc



Software Application CD
(Mac version available
online)



Power Adapter x 1pc
100-240V AC to 5V USB DC
Notice: Actual Shape may vary.

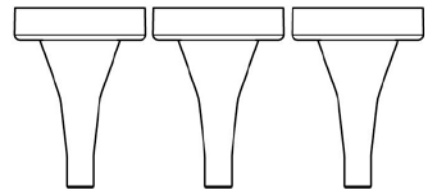

Specula (S/M/L) x 3 sets

NOMENCLATURE

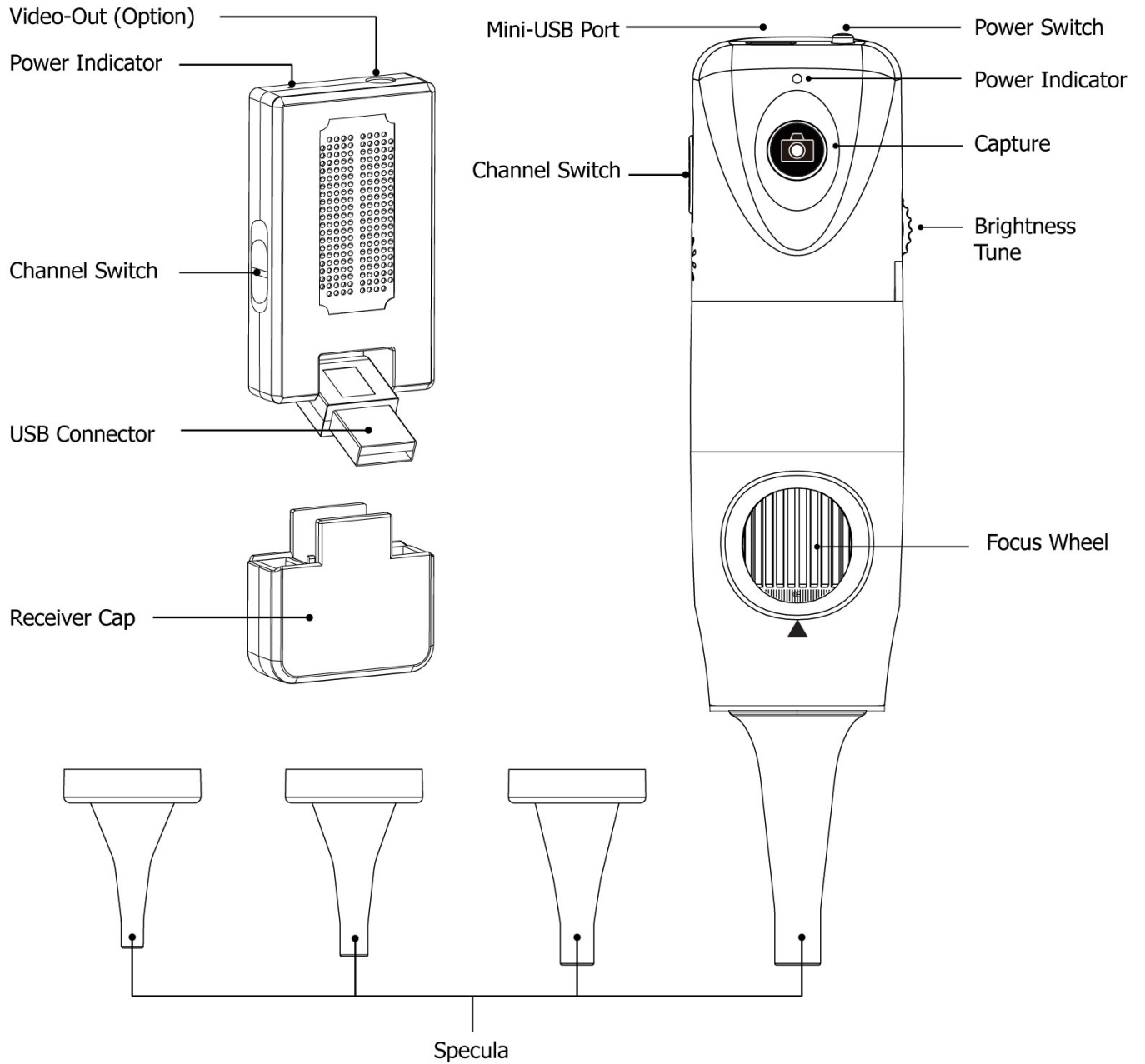

OPERATION

Setting up the otoscope with specula:



Only accepts original specula qualified for use with Firefly otoscopes.

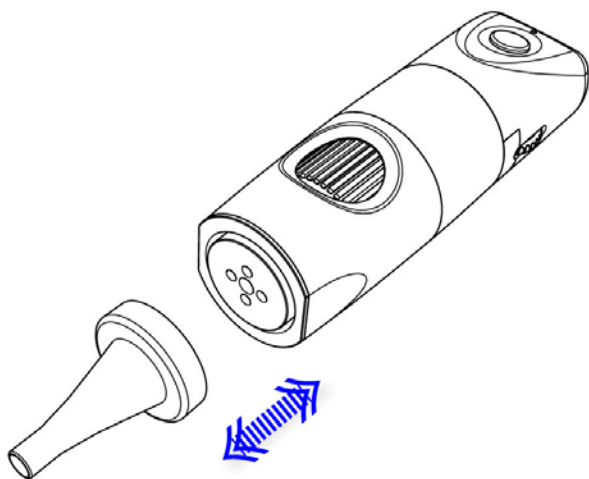

Plug the specula into the round concave guide in front. To remove: Simply pull to unplug the specula.

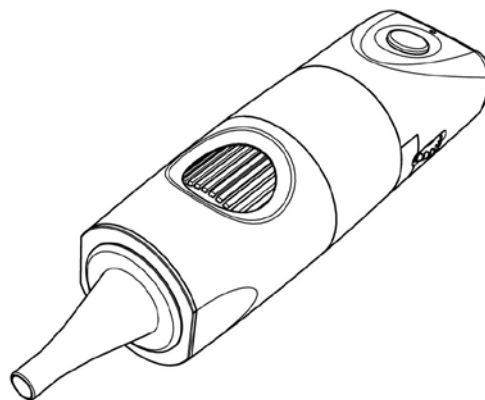

Ensure a tight fit for proper operation and adjust specula such that the circular opening is centered on the screen.

Setting up the Software Application:

Prior to using the Firefly Otoscope for the first time, install the FireflyPro software application following the instructions provided with the installation CD.

Connect to PC:

Connect the compact receiver to the PC's USB port.

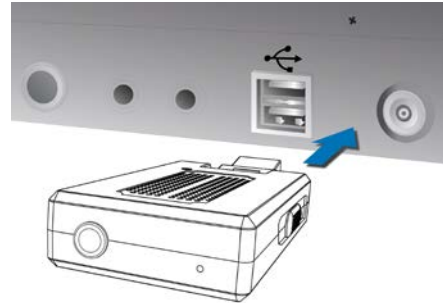
**Power the Device On:**

Push the 'Power Button' at the rear of the otoscope to activate the device. An indicator light will turn on to confirm the power status.

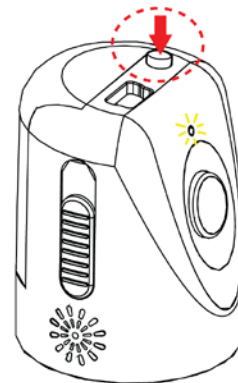
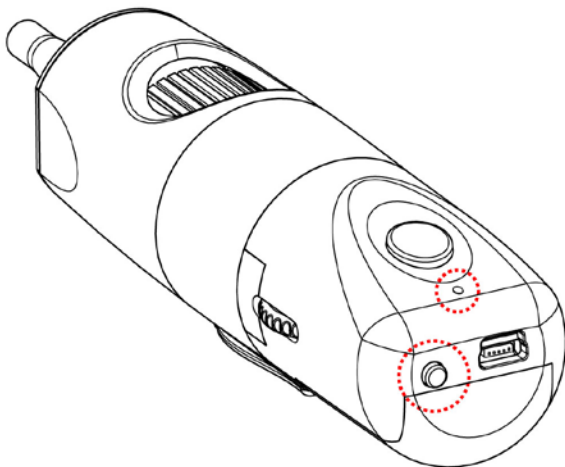

Charging the Battery:

■ Duration:

The Wireless Firefly Oscope has a built-in high efficiency lithium battery that enables more than 2.5 hours continuous operation.

■ Charging the Battery:

Through the mini-USB port at the rear of the oscilloscope, the embedded battery can be charged with the provided USB DC cable. The cable must be connected to the USB port of a PC or to the "USB Power Adapter", which can charge directly from a wall outlet.

■ Overload Protection:

The overload protection circuit will prevent overcharging when the battery is full and the "Indicator" will turn green.

■ Power Indication:

The power indicator light is normally red during operation, but it will turn blue when the remaining battery life is less than 30 minutes.



The lithium battery is a delicate and consumable item. It is expected to last through years of use and is guaranteed for twelve months from its purchase against defects. If there is any battery related issue, please contact customer service immediately. Battery replacement by unauthorized personnel or replacement with unauthorized batteries may damage the system and voids the overall warranty.

Channel Mapping:

On the rear right side of the oscilloscope, there is a switch allowing users to set the wireless channel. Both the receiver and oscilloscope must be set to the same channel for proper operation:

- ◆ CH 1: Channel 1
- ◆ CH 2: Channel 2
- ◆ CH 3: Channel 3
- ◆ CH 4: Channel 4

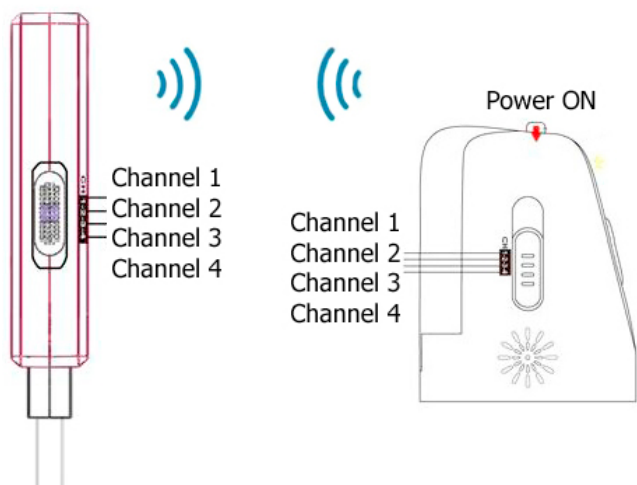

Recommended holding position:

It is suggested to hold the otoscope, transparent cover forward, with the thumb held on the equipment. This holding position offers relative stability and allows lens control. The index finger is still free to rotate and adjust the focus wheel (as shown).



Brightness Adjustment:

On left rear side of the otoscope, a knob allows the user to control the brightness of the LEDs:

- ◆ Backward Turn: Decrease Brightness
- ◆ Forward Turn: Increase Brightness

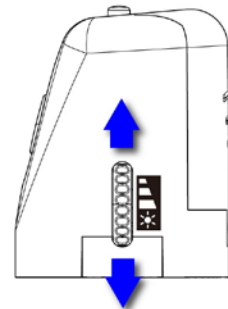

Using the Image Capture Control:

Press and release the Capture button to capture image frames. The system will generate a shutter sound from the PC speaker as confirmation.

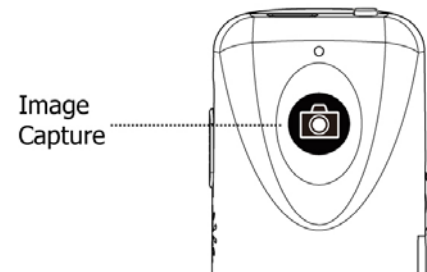

Using Focus:

Based on the relative distance of the observed object, the focus wheel can be turned for a clear image. When a higher magnification is required, the focus wheel can be turned to the left (see below). If a larger field of view is required, the otoscope can be moved farther away and the wheel turned to the right.

Default Position: Match "50" to the triangular marker

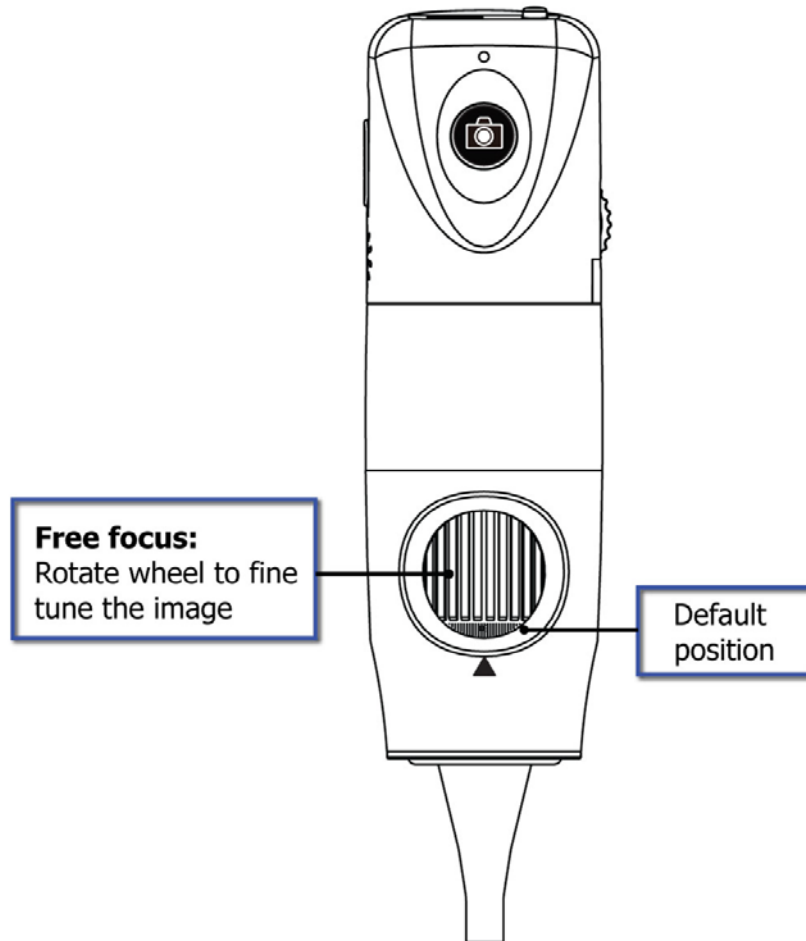

Standby and Remove device:

To temporarily turn off or remove the device, push and release the power button to the "OFF" position.

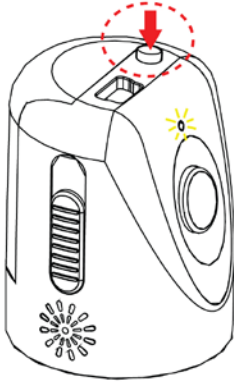

Next, exit the FireflyPro software application. You can then remove the USB receiver from the PC.

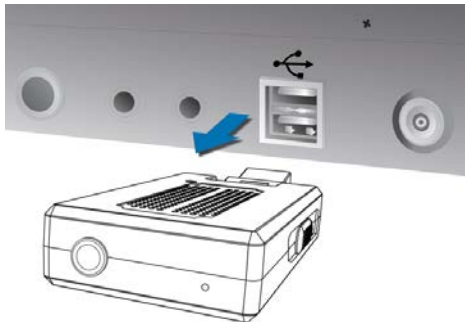

Launching the Software Application for Windows:

Double-click the FireflyPro.app icon on your computer desktop:



Viewing the Images:

FireflyPro software controls your Firefly Otoscope. The Otoscope communicates with the PC through the USB compact receiver. The user can configure the video properties, review live images, capture images, record video clips and perform a variety of powerful measurement and documentation functions.

The main features of FireflyPro are shown below:

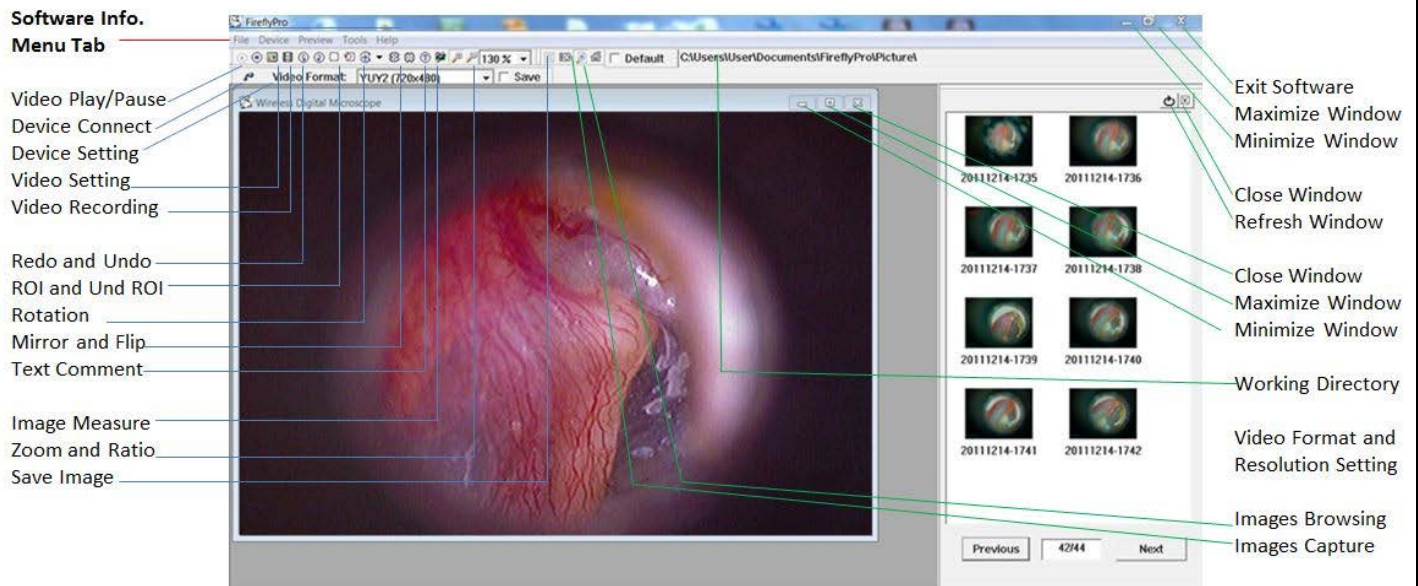

Saving Images:

There are three ways to save an image:

1. Pressing the snapshot button on the Firefly device.
2. Clicking the Camera icon in the menu bar.
3. Pressing the center button on your mouse (middle click).

Changing Image File Type:

Select between BMP, JPG-lossless or JPG-recommend image file types. There are two ways to change the image file type:

1. Change the Default Image File Type:

In the menu bar go to Device > Settings, then select the desired image file type using the Image Format dropdown selection. This will set the default format for all captured images.

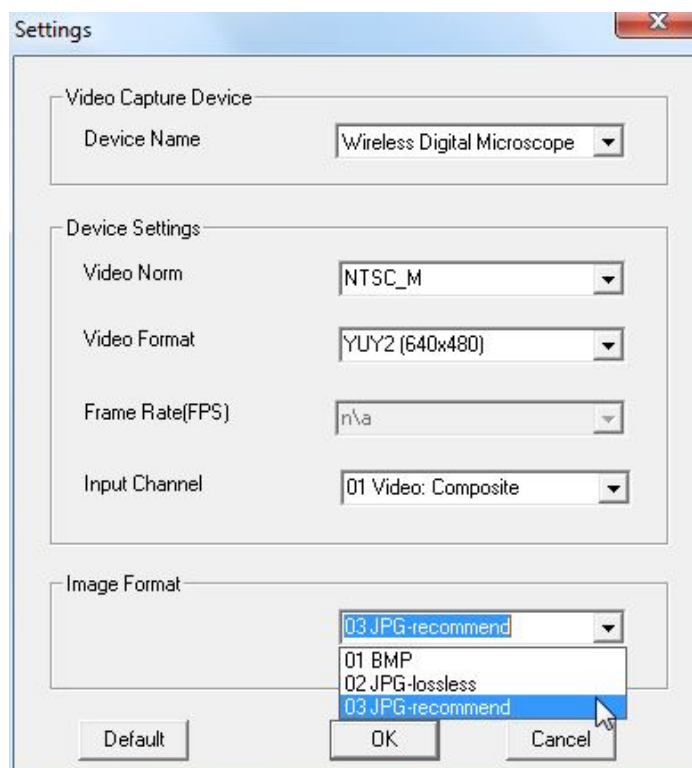

2. Change the Format of an Existing Image

From the Image View Bar, Right click on an image and select Save as. Then select the file type from the dropdown and click Save.

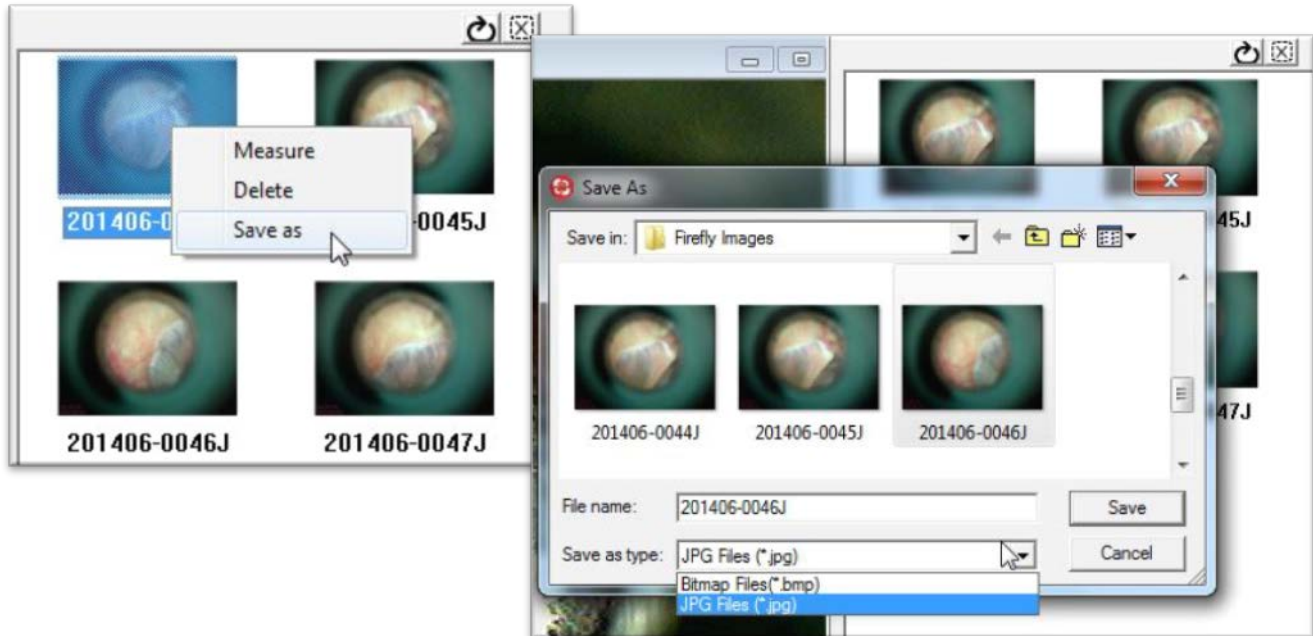

Changing the Location where Images are Saved

Changing the Location of an Image Already Taken:

Right click on the image in the Image View Bar and click Save As. You can then select the saving location on your computer using the dropdown directory field at the top of the window.

Changing the Default Location for Saving Images:

Click the 'Save picture path' icon.  Select the desired location from the drop down directory and click OK. Next to the 'Save picture path' icon is a Default checkbox. **Default** Check this box if you wish to save the new picture path as the default location for saving images.

Tool bars:

The Tools bars enable quick access to the functions of FireflyPro software. The tool bars can be grouped into Control, Images and Device tool bar sets.

Control Tool bar:



Icon	Icon Name	Function Description
	Play	Start the video stream preview
	Pause	Freeze live video image frame
	Video Setting	Configure video properties
	Video Recording	Video recording and settings (frame, period, quality, codec etc...)
	Undo	Undo the previous Rotation, Text Comment and Zoom
	Redo	Redo the previous Rotation, Text Comment and Zoom
	ROI	Select region of interest (ROI) on live video stream
	Undo ROI	Revoke ROI selection
	Rotation	Rotate live video 0°, 90°, 180°, 270°
	Mirror	Mirror live video horizontally
	Flip	Flip live video vertically
	Text Comment	Add text layer on image
	Image Measure	Launch image measurement application
	Zoom +	Zoom-in live video up to 300%
	Zoom -	Zoom-out live video down to 10%
	Zoom Ratio	Set Zoom ratio from 10-300

Image tool bar:



Icon	Icon Name	Function Description
	Save Image	Store frozen image
	Image Capture	Capture and store instant image from live video
	Image Browsing	Browse images in working directory
	Working Directory	Pop-up to select working directory path
	C:\Documents and Settings\My Documents\Firefly\Picture	Working directory path

Device Tool bar:

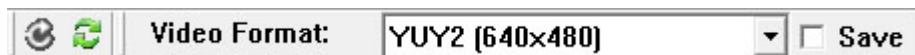

Icon	Icon Name	Function Description
	Refresh Camera View	Refreshes the live video connection in the camera window
	Select Device	Select the proper device for best results
	Change Video Format	Select between multiple video and resolution options
	Save Video Format	Saves the selected video format as new default format

Note: Make sure you have the proper device selected. If you're not sure use the Select Device icon.

Launching the Software Application for Mac:

Double-click the FireflyPro.app icon on your computer desktop:

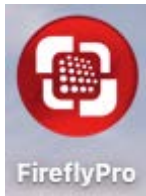

Viewing the Images:

FireflyPro software controls your Firefly Otoscope. The Otoscope communicates with the Mac through the USB compact receiver. The user can configure the video properties, review live images, capture images, record video clips and perform a variety of documentation functions.

The main features of FireflyPro are shown below:

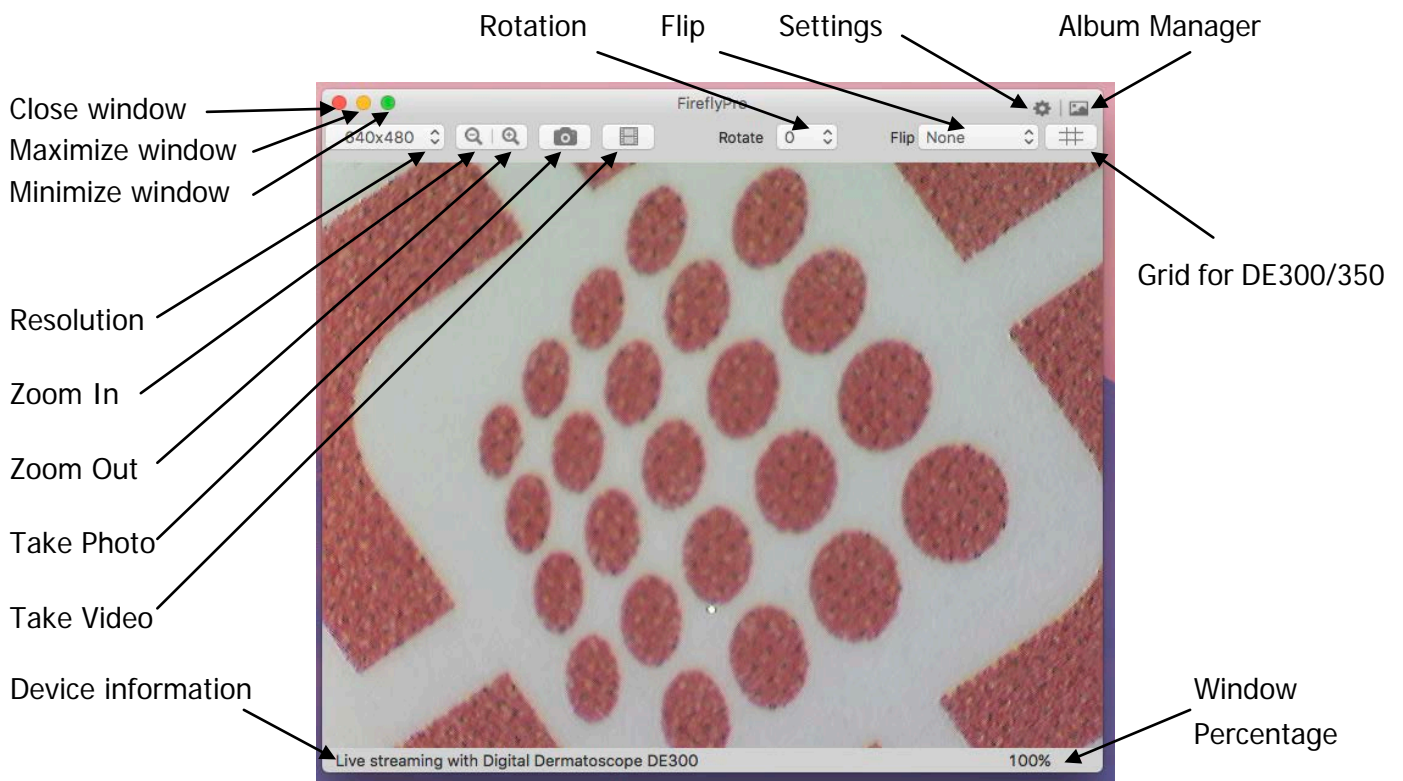

Album Manager Feature

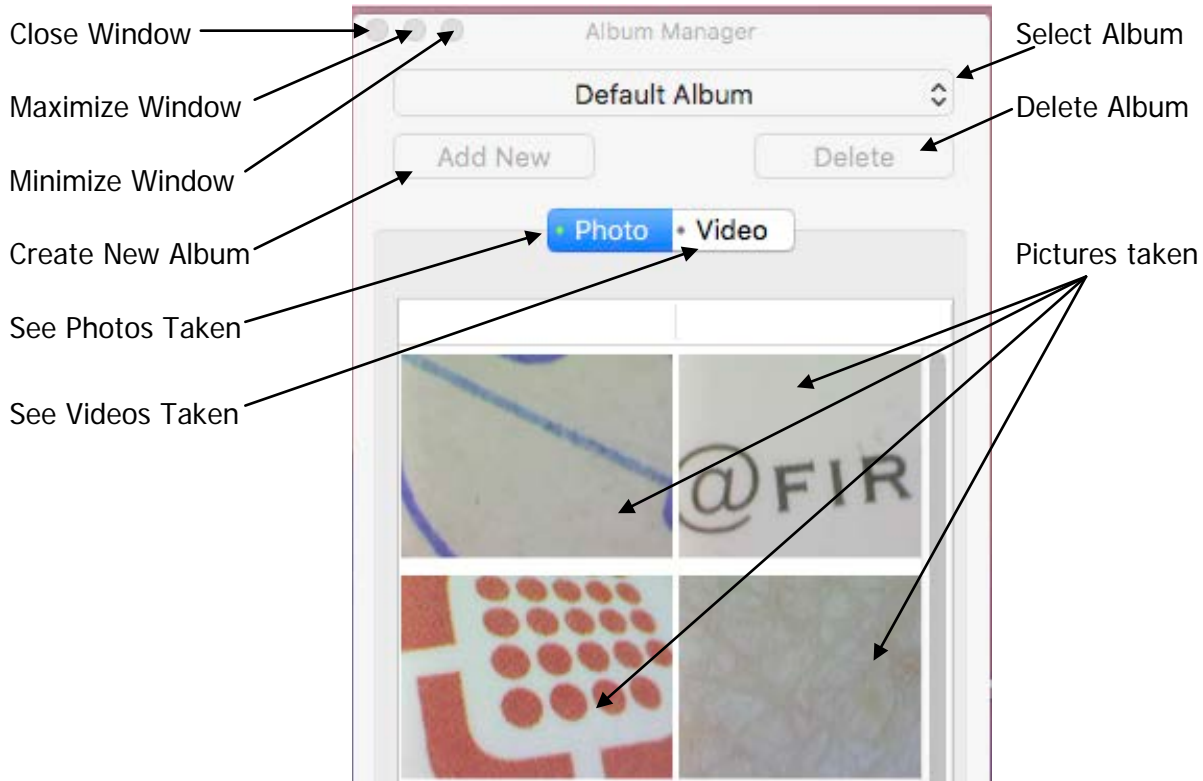

Selecting correct device:

1. Open  -> select the Firefly product you are using

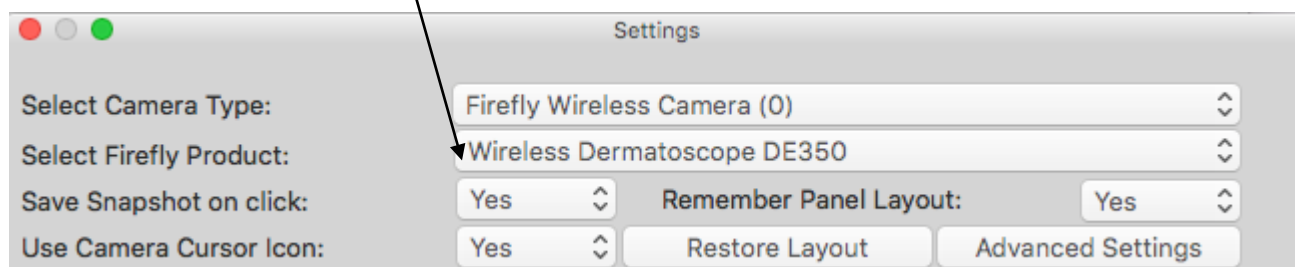

Saving Images:

There are three ways to save an image:

1. Pressing the snapshot button on the Firefly device
2. Clicking the camera icon on the interface
3. Clicking when the camera icon is visible in live video monitor

Saving Videos:

There is only one way to save a video:

1. Clicking the video icon

Deleting an Image or Video Already Taken:

1. In album manager -> click the image or video you want to delete once and drag it to trash

Renaming an Image or Video already taken:

1. In album manager, double click the video -> double click on the name of the video-> rename the video

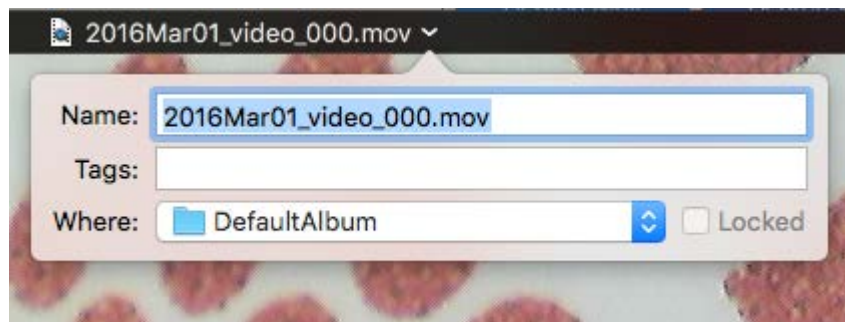

Creating a New Folder:

1. In album manager, Open Add New -> Click New Folder -> Name the Folder.

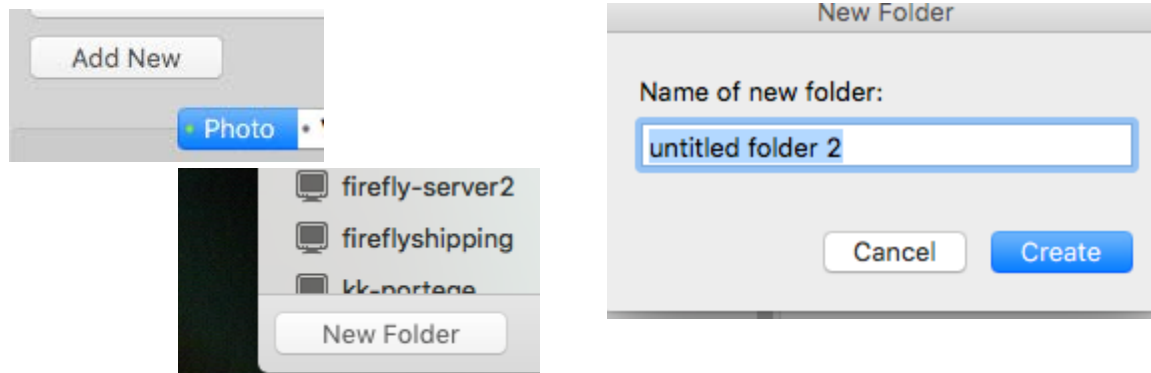

Creating a New Default Folder:

1. After saving picture, Select where -> Select location or create a new folder
2. Make the New Folder or Location the default folder by using the select album directory
3. Go back to Firefly Pro album manager and select the location or new folder

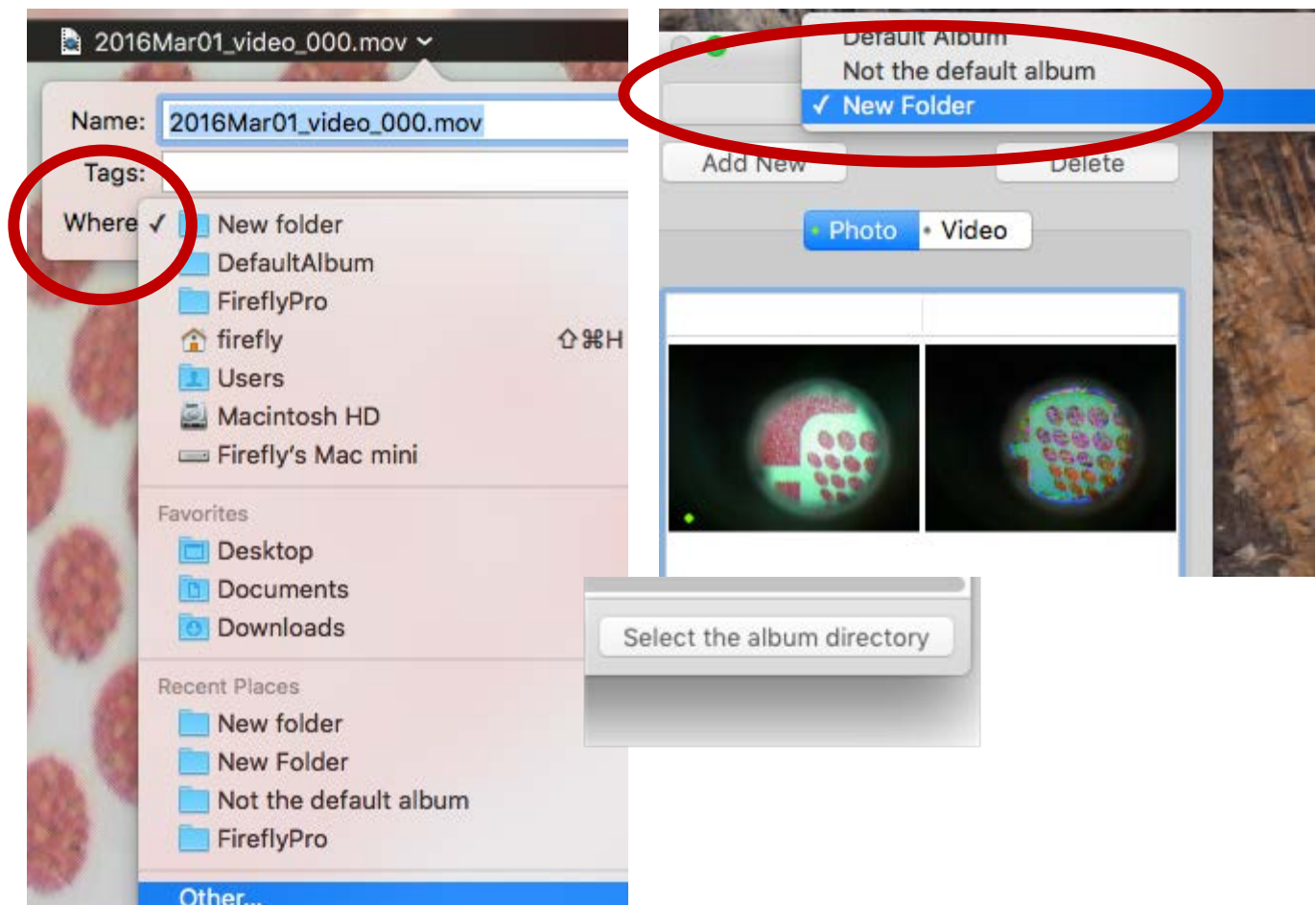





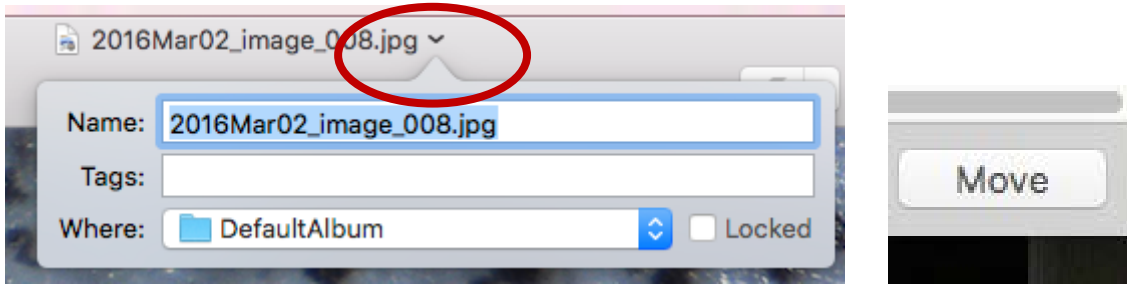

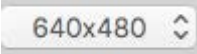

Moving an Image to a New Location (same steps as a new default folder)

1. After opening image, click where -> select new location -> click move

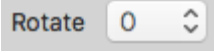
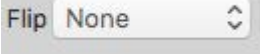

Icons and Functions

	Determines the resolution
	Zoom in and out on live video from 10% to 150%
	Taking a photo
	Recording a video
	Rotating the image 90, 180, or 270 degrees
	Flip the image vertical, horizontal or both
	Grid for the DE300/350 to measure a 5x5mm area
	Settings to select the device you are using
	Album manager to view saved images and videos

MAINTENANCE AND SERVICE

Cleaning recommendation



CAUTION Do not apply alcohol, chemicals, or water to the lens. Any liquids entering the optical assembly will damage internal components.

Use a dry cloth to clean the Digital Firefly Otoscope System on a weekly basis.

Recycling the system components

Within the EU



Do not dispose of this product as unsorted municipal refuse. Submit for separate collection as specified by Directive 2002/96/EC of the European Parliament and the Council of the European Union on Waste Electronic and Electrical Equipment (WEEE).

If this product is contaminated, this directive does not apply. For more specific disposal information contact Customer Service.



Outside the EU

When the product and its components reach end of life, recycle the product according to national, state, and local regulations.

SERVICE POLICY

All repairs on products under warranty must be performed or approved by Firefly or its authorized resellers. Unauthorized repairs will void the warranty. In addition, whether or not covered under warranty, any product repair shall exclusively be performed by Firefly-certified service personnel.

If the product fails to function properly — or if you need assistance, service, or spare parts — contact your Firefly reseller.

Before contacting your reseller, try to duplicate the problem and check all accessories to ensure that they are not causing the problem. When calling, please be prepared to provide:

- Product name and model number and complete description of the problem.
- Serial number of your product (if applicable).
- Complete name, address and phone number of your facility.
- For out-of-warranty repairs or spare parts orders, a purchase order (or credit card) number.
- For parts orders, the required spare or replacement part numbers.

If your product requires warranty, extended warranty, or non-warranty repair service, please contact your Firefly reseller. A customer service representative will assist you in troubleshooting the problem and will make every effort to solve it over the phone, avoiding potential unnecessary returns. In case a return cannot be avoided, the representative will record all necessary information and will provide a Return Authorization number, as well as the appropriate shipping address. The Return Authorization number must be obtained prior to any return.

If you have to return your product for service, follow these recommended packing instructions:

- Disconnect all hoses, cables, sensors, power cords, and ancillary products (as appropriate) before packing, unless you suspect they are associated with the problem.
- Wherever possible use the original shipping carton and packing materials.
- Include a packing list and the Return Authorization number.

It is recommended that all returned goods be insured. Claims for loss or damage to the product are the responsibility of the sender.

SPECIFICATIONS

Item	Specification
Weight	Approximately 100 g (0.22 lb)
Dimensions (approximate)	Length: 11.4 cm (4.5 inches) Height: 3.7 cm (1.5 inches) Width: 3.7 cm (1.5 inches)
Ratio	USB 5 VDC, 150mA
Protection against ingress of water	IPXØ
Operating conditions	
Temperature	+10°C to +40° C (+50°F to +104°F)
Relative humidity	30% to 75% noncondensing
Altitude	700 to 1060 hPa
Shipping & storage conditions	
Temperature	-20°C to +49°C (-4°F to +120°F)
Relative humidity	95% noncondensing max.
Wireless power	Less than 10mW
Sensitivity	-87dBm
Noise ratio	47dBm
Antennae resistance	50Ω
Available Channels	4
Coverage	Over 5 meters (15ft) on open field
Battery	More than 2.5 hours continuous usage
Capacity	850mAh (Lithium battery)
Service	Authorized personnel only
Safety Compliance	FCC, CE and RoHS compliant
Patent	Patent Pending

LIMITED WARRANTY

Limited Hardware Warranty (through distributors & resellers)

Firefly Global hardware products come with a 1-year limited hardware warranty. The warranty is extended through Firefly Global authorized representatives and resellers. If you have a warranty claim, please contact the store, distributor, or website through which the product was purchased.

Register your Firefly device at <http://www.fireflyglobal.com/warranty-registration/> within two weeks of your purchase and maintain your original receipt.

What is covered by this limited hardware warranty?

This limited hardware warranty covers defects in materials and workmanship in your Firefly Global hardware products.

What is not covered by this limited hardware warranty?

This limited hardware warranty does not cover:

- Software, including the operating system and software added to or bundled with the Firefly Global hardware products
- Problems that result from:
 - External causes such as accident, abuse, misuse, or problems with electrical power
 - Servicing not authorized by Firefly Global
 - Usage that is not in accordance with product instructions
 - Failure to follow the product instructions
 - Problems caused by using accessories, parts, or components not supplied by Firefly Global
- Products with missing or altered serial numbers
- Products for which Firefly Global or its distributors have not received payment
- Normal wear and tear

THIS WARRANTY GIVES YOU SPECIFIC LEGAL RIGHTS, AND YOU MAY ALSO HAVE OTHER RIGHTS WHICH VARY FROM STATE TO STATE (OR JURISDICTION TO JURISDICTION). FIREFLY GLOBAL'S RESPONSIBILITY FOR MALFUNCTIONS AND DEFECTS IN HARDWARE IS LIMITED TO REPAIR AND REPLACEMENT AS SET FORTH IN THIS WARRANTY STATEMENT. ALL EXPRESS AND IMPLIED WARRANTIES FOR THE PRODUCT, INCLUDING BUT NOT LIMITED TO ANY IMPLIED WARRANTIES AND

CONDITIONS OF MERCHANTABILITY AND FITNESS FOR A PARTICULAR PURPOSE, ARE LIMITED IN TIME TO THE TERM OF THE LIMITED WARRANTY PERIOD REFLECTED ON YOUR PACKING SLIP OR INVOICE. NO WARRANTIES, WHETHER EXPRESS OR IMPLIED, WILL APPLY AFTER THE LIMITED WARRANTY PERIOD HAS EXPIRED. SOME STATES DO NOT ALLOW LIMITATIONS ON HOW LONG AN IMPLIED WARRANTY LASTS, SO THIS LIMITATION MAY NOT APPLY TO YOU.

WE DO NOT ACCEPT LIABILITY BEYOND THE REMEDIES PROVIDED FOR IN THIS LIMITED HARDWARE WARRANTY OR FOR CONSEQUENTIAL OR INCIDENTAL DAMAGES, INCLUDING, WITHOUT LIMITATION, ANY LIABILITY FOR THIRD-PARTY CLAIMS AGAINST YOU FOR DAMAGES, FOR PRODUCTS NOT BEING AVAILABLE FOR USE, OR FOR LOST DATA OR LOST SOFTWARE. OUR LIABILITY WILL BE NO MORE THAN THE AMOUNT YOU PAID FOR THE PRODUCT THAT IS THE SUBJECT OF A CLAIM. THIS IS THE MAXIMUM AMOUNT FOR WHICH WE ARE RESPONSIBLE.

How long does this limited hardware warranty last?

The limited hardware warranty on all Firefly Global products begins on the date of the packing slip, invoice, or receipt. The warranty period is not extended if a warranted product or any parts are repaired or replaced. Firefly Global may change the availability of limited hardware warranties, at its discretion, but any changes will not be retroactive.

What do I do if I need warranty service?

Before the warranty expires, please contact the store, distributor, or website through which the product was purchased.

What will Firefly Global do?

Firefly Global or its authorized representative or reseller will repair any Firefly Global hardware products returned that prove to be defective in materials or workmanship. If Firefly Global or its authorized representatives are not able to repair the product, we will replace it with a comparable product that is new or refurbished.

When you contact our authorized representatives or resellers via phone or email, they will issue a Return Material Authorization Number for you to include with your return. You must return the products in their original or equivalent packaging, prepay shipping charges, and insure the shipment or accept the risk if the product is lost or damaged in shipment. The repaired or replacement products will be returned to you. The reseller or authorized representative will pay to ship the repaired or replaced products to you if you use a delivery address in the country where the reseller is located. Otherwise, the product will be shipped to you freight collect.

If it is determined that the problem is not covered under this warranty, you will be notified and informed of service alternatives that are available to you on a fee basis.

How will you fix my product?

We use new and refurbished parts made by various manufacturers in performing warranty repairs and in building replacement parts and systems. Refurbished parts and systems are parts or systems that have been returned to Firefly Global, some of which were never used by a customer. All parts and systems are inspected and tested for quality. Replacement parts and systems are covered for the remaining period of the limited hardware warranty for the product you bought. Firefly Global owns all parts removed from repaired products.

May I transfer the limited hardware warranty?

Limited hardware warranties are not transferable.

TROUBLESHOOTING

Please visit the FAQ section of our website for the latest troubleshooting information and additional support. <http://www.fireflyglobal.com/>

Thank you for choosing Firefly.



www.fireflyglobal.com